

DMP40

User Manual



www.audac.eu

ADDITIONAL INFORMATION

This manual is put together with much care, and is as complete as could be on the publication date. However, updates on the specifications, functionality or software may have occurred since publication. To obtain the latest version of both manual and software, please visit the Audac website @ www.audac.eu.

Index

Introduction	5
Precautions	6
Safety requirements	6
Caution servicing	7
EC Declaration of Conformity	7
Waste of Electrical and Electronic Equipment (WEEE)	7
Chapter 1: Connections and connectors	8
Connection standards	8
Chapter 2: Overview DMP40	9
Chapter 3: Using the DMP40	11
Module screen	11
Settings screen	13
Chapter 4: Installing the DMP40	15
Chapter 5: Additional information	17
Technical specifications	17
Notes	18

Introduction

SourceCon™ DAB/DAB+ & FM tuner module

The DMP40 is a professional DAB/DAB+ & FM tuner featuring SourceCon™ modular technology. This unique technology guarantees true plug & play implementation to any compatible device. When inserted to a supporting slot, the module is instantly installed, discovered and ready for operation without requiring any additional internal wiring or complex configuration.

The DMP40 provides access to a wide variation of radio stations while guaranteeing a high quality audio reproduction. Station selection can be done manually or automatically, while up to 10 preferred channels can be internally stored and recalled. Radio station information carried by RDS / Radiotext can be retrieved, while other functions such as mono/stereo switching (FM) always guarantee the best possible audio clarity.

The signal output level is user configurable, while dynamic range compression (DRC) is supported, improving the intelligibility for low volumes in applications with high levels of background noise. Signal reception strength can be retrieved from the module and indicated on the graphical interface of the controlling device.

The antenna input is implemented by an F-type connector on its panel, allowing connection of the included antenna cable or any other external antenna using 75 Ω coaxial cabling. The balanced stereo line output is connected through two 3-pin terminal block connections.

Precautions

READ FOLLOWING INSTRUCTIONS FOR YOUR OWN SAFETY

- ALWAYS KEEP THESE INSTRUCTIONS FOR FUTURE REFERENCE. NEVER THROW THEM AWAY
- ALWAYS HANDLE THIS UNIT WITH CARE
- HEED ALL WARNINGS AND FOLLOW ALL INSTRUCTIONS
- AVOID ELECTROSTATIC DISCHARGE BY TOUCHING GROUNDED POINT BEFORE REMOVING THE MODULES FROM THEIR PROTECTIVE BAG
- AVOID TOUCHING OF THE COMPONENTS ON THE CIRCUIT BOARD DIRECTLY
- NEVER EXPOSE THIS EQUIPMENT TO RAIN, MOISTURE, ANY DRIPPING OR SPLASHING LIQUID. NEVER PLACE AN OBJECT FILLED WITH LIQUID ON TOP OF THIS DEVICE
- DO NOT INSTALL THIS UNIT NEAR ANY HEAT SOURCES SUCH AS RADIATORS OR OTHER APPARATUS THAT PRODUCE HEAT
- DO NOT PLACE THIS UNIT IN ENVIRONMENTS WITH A HIGH LEVEL OF DUST, HEAT, MOISTURE OR VIBRATION
- THIS UNIT IS DEVELOPED FOR INDOOR USE ONLY. DO NOT USE IT OUTDOORS
- ONLY USE ATTACHMENTS & ACCESSORIES SPECIFIED BY THE MANUFACTURER.
- UNPLUG THIS APPARATUS DURING LIGHTNING STORMS OR WHEN UNUSED FOR LONG PERIODS OF TIME
- CAREFULLY CHECK THE UNIT'S CONDITION AFTER UNPACKING. IF THERE IS ANY DAMAGE TO THE CARTON BOX OR THE UNIT ITSELF, INFORM YOUR VENDOR IMMEDIATELY.
- ONLY CONNECT THIS UNIT TO A MAINS SOCKET OUTLET WITH PROTECTIVE EARTHING CONNECTION
- THE INSTALLATION, CONNECTION AND CONFIGURATION OF THE DEVICE SHOULD BE DONE BY QUALIFIED TECHNICIANS



CAUTION – SERVICING

This product contains no user serviceable parts. Refer all servicing to qualified service personnel. Do not perform any servicing (unless you are qualified to do so.)



EC DECLARATION OF CONFORMITY

This product conforms to all the essential requirements and further relevant specifications described in following directives: 2014/30/EU (EMC) and 2014/35/EU (LVD)



WASTE ELECTRICAL AND ELECTRONIC EQUIPMENT (WEEE)

The WEEE marking indicates that this product should not be disposed with regular household waste at the end of its product life. This regulation is created to protect both the environment and human health.

This product is developed and manufactured with high quality materials and components which can be recycled and/or reused. Please dispose of this product at your local collection point or recycling centre for electrical and electronic waste. Do this to make sure that the product is recycled in an environmental friendly way, and help to protect the environment in which we all live.

CAUTION

The symbols shown are internationally recognized symbols that warn about potential hazards of electrical products. The lightning flash with arrowpoint in an equilateral triangle means that the unit contains dangerous voltages. The exclamation point in an equilateral triangle indicates that it is necessary for the user to refer to the users manual.



These symbols warn that there are no user serviceable parts inside the unit. Do not open the unit. Do not attempt to service the unit yourself. Refer all servicing to qualified personnel. Opening the chassis for any reason will void the manufacturer's warranty. Do not get the unit wet. If liquid is spilled on the unit, shut it off immediately and take it to a dealer for service. Disconnect the unit during storms to prevent damage.

Chapter 1

Connections and connectors

CONNECTION STANDARDS

The in- and output connections for AUDAC audio equipment are performed corresponding to international wiring standards for professional audio equipment.

3-Pin terminal block:

For balanced in & output connections

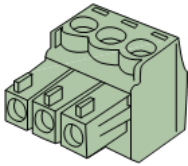

Left:	Signal –	(XLR Pin 3)
Center:	Signal +	(XLR Pin 2)
Right:	Ground	(XLR Pin 1)

For balanced line output connections:

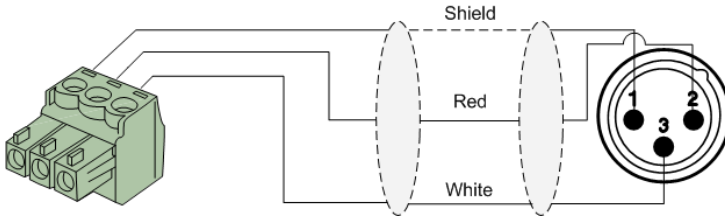

For unbalanced line output connections:

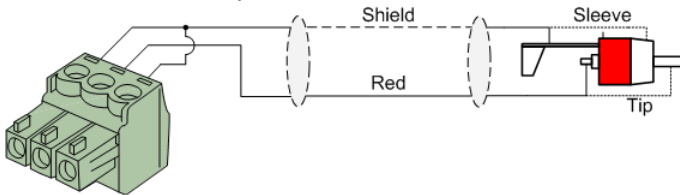

Chapter 2

Overview DMP40

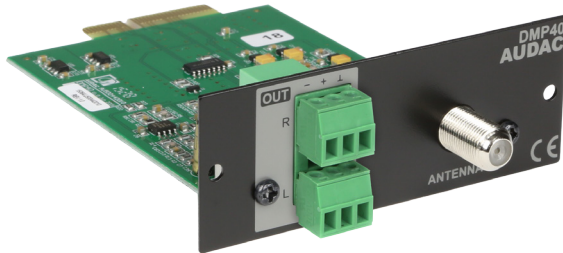

The DMP40 is a SourceCon™ compatible module featuring an (internal) board–edge connector which carries all signals for getting it connected to any supporting main unit.

All external in & output connections shall be made using the available connectors on the panel.

1) Balanced stereo line output:

The balanced stereo line output is implemented using two 3–pin terminal block connectors. The audio output available on this connector allows it to be fed to any amplifier or pre–amplifier.

2) F–type antenna connection:

The antenna (input) connection is implemented using an F–type connector where to the supplied antenna should get connected. Depending of the installation conditions, location and signal strength, it can be recommended / necessary to extend the antenna using 75Ω coaxial cable and connect an external or outdoor antenna.

3) Antenna power supply jumper (5V):

An internal jumper enables a 5 Volts supply on the antenna connection for powering active antennas. Active antenna's include a small signal amplifier, improving reception and signal transmission to the receiver.

In default configuration the antenna power supply is disabled. Enabling is done by changing the position of the corresponding jumper as indicated below.

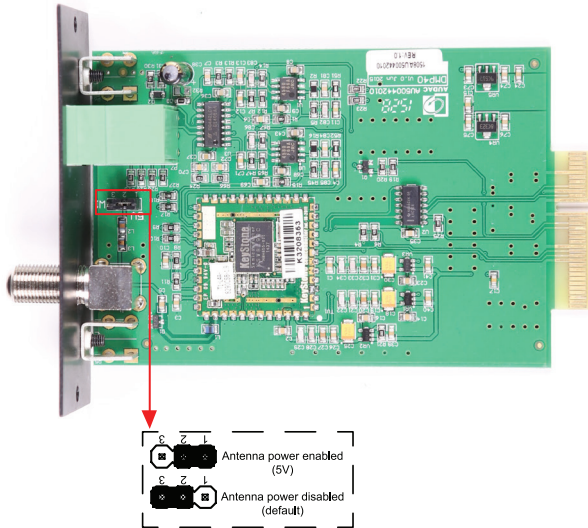

Indication of antenna power jumper positions on DMP40

NOTE

Verify whether the connected antenna is an active or a passive model. When enabled the antenna power supply to a passive model, permanent damage to the equipment might occur. The default supplied (included) antenna is a passive model, not requiring the antenna power to be enabled.

Chapter 3

Using the DMP40

Since the DMP40 is a SourceCon™ module, it can be combined with a variation of supporting main units. The operation and configuration interface might be different of the unit where installed, however the offered functionality is identical. Some devices will support control and configuration through a front panel graphical control interface on a display, while others are also supporting web-control.

This manual describes the control configuration possibilities using front panel control. For applications where more control possibilities are offered, check the instruction manual of the used main device for more instructions.

Module screen

FM Radio station selection:

- Automatic tuning:

The currently playing FM radio station (if FM mode is enabled) is selected by pressing the ◀◀ (tuning down) and ▶▶ (tuning up) buttons. When pressed, it will automatically start searching for the next station with sufficient signal strength. The currently tuned frequency will be indicated at the center of the screen, also indicating additional carried RDS information (if available) such as the currently playing station or track name.

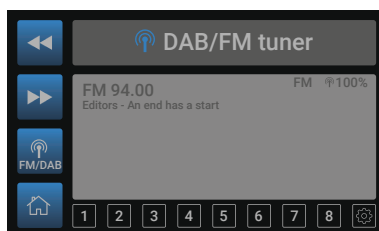

- Manual tuning:

The tuning frequency can be manually adjusted by rotating the function dial until the tuned frequency is highlighted in blue colour. When highlighted, confirm manual tuning adjustment by single pressing the rotary dial and adjust the tuner frequency by rotating clockwise (tuning up) or counter-clockwise (tuning down). Once tuned to the desired frequency, conform the tuned frequency by single pressing the function dial once again.

DAB Radio station selection:

The currently playing DAB radio station (if switched to DAB mode) is selected by pressing the ◀◀ (tuning down) and ▶▶ (tuning up) buttons. When pressed, it will automatically switch to the next available station.



The currently playing station name is shown, together with additional carried Radiotext station information such as the currently playing program or track name. More information such as signal reception strength, the number of available DAB radio stations and the bitrate of the currently playing station is shown on the right side of the screen.

FM/DAB switching:

Switching between DAB and FM mode is done by pressing the  (DAB/FM) button. The current mode (FM or DAB) is shown on the display in front of the tuning frequency or station name. When switching to DAB mode for the first time, all available stations will be scanned first.

Save radio station:

The currently playing station can be stored to one of the 10 available positions. A horizontal array with numbers from 1 to 10 is indicated on the bottom of main tuner screen, representing the 10 positions whereto the presets can be saved. Rotate the function dial until the number for radio station storage is highlighted, and press the  (save) icon for saving the currently selected frequency to the selected position.

Recall radio station:

A stored radio station can be recalled by rotating the function dial until the number on the horizontal array on the bottom of the main tuner screen is highlighted. When highlighted, confirm the recall of the stored frequency by single pressing the function dial. The stored frequency under this position is now recalled and the radio station will start playing.

Home:

The  (home) button gets you back to the main screen of the device where the TMP40 is installed to.

Settings screen

The settings menu for DMP40 can be loaded by rotating the rotary dial until the  (settings) symbol is highlighted in blue colour. When highlighted, confirm to proceed to the settings menu by single pressing the rotary dial.

Output gain:

The gain can be adjusted within a range of +8 dB and -32 dB, allowing optimization of the output level according to the input sensitivity of the connected amplifier or pre-amplifier. For adjusting the output gain, rotate the function dial until 'Gain' is highlighted and press it for proceeding to the gain settings. The level can be adjusted by rotating clockwise (tuning up) or counter-clockwise (tuning down). Press the rotary dial for confirming the currently set output level.



Mono:

The FM reception is standard set to stereo mode, however it will switch automatically to mono mode if the signal reception strength is insufficient. This reduces the noise and improves the sound quality when having poor signal reception.

Manual switching the output to mono mode is possible using this function, allowing the output to be fed to mono systems, such as 100V public address amplifiers. Toggling between mono and stereo mode can be done by single pressing the function dial.

DAB DRC:

The DRC (Dynamic Range Compression) increases the loudness of the signal in the quieter parts of the audio signal and decreases it in the louder parts. This technique allows quieter parts of the audio signal still being audible in situations with high background noise without blasting out. It can be switched between Off, Low and High. DRC data is carried by an additional side channel of DAB radio station and is only functional when the selected radio station carries the DRC data.

DAB info:

Gives additional information about the currently playing DAB radio station. Displayed information includes station name, currently playing program or track name, signal reception strength, bitrate, ...

DAB search:

Clears all stored DAB channels from the memory and scans the entire bandwidth for available DAB/DAB+ channels. DAB search is automatically performed when initially switched to DAB mode, but shall be re-done when any change to available channels or position of the receiver is made.

Factory reset:

Factory reset will recall all settings to factory defaults and all previously made settings and configurations will be lost. After selecting factory reset, a confirmation will be asked whether all settings definitely need to be reset to factory defaults. When confirmed, all settings will be lost.

Back:

Returning to the module screen is done by selecting 'Back'.

Chapter 4

Installing the DMP40

CAUTION



Before installing the DMP40 to any SourceCon™ compatible device, make sure the power is switched off. Malfunctions or electrical shocks may occur otherwise.

Step 1:

Make sure that the slot where the module should be installed is open and ready for installation. Depending on the main unit, some module slots will be covered by blind panels when delivered. The corresponding blind panels should be removed by releasing the screws on both ends.

Step 2:

Before removing the modules from their protective bag, we recommend touching a grounded metal chassis (or any other grounded point) to prevent electrostatic discharges affecting the sensitive electronic components. It is recommended to always hold the module card by the metal connection panel and avoid touching of the components on the circuit board directly.

Step 3:

Align both edges of the module with the guide rails inside the slot and carefully insert the module into the slot. It should slide into the slot without any considerable resistance when well positioned into the guide rail.

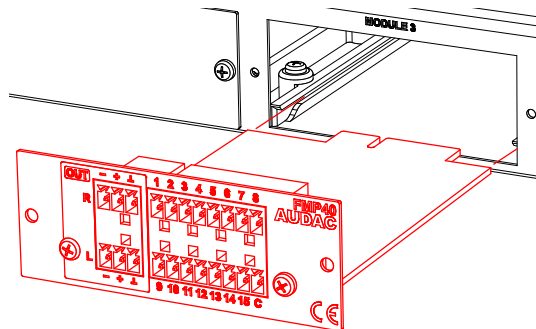

Step 4:

Some resistance might occur when the module's board edge connector reaches the connection counterpart on the main board. Gently push the module all the way into the slot to ensure that the contacts are correctly inserted. The module is well inserted when its connection panel touches the metal chassis of the main device where inserted to.

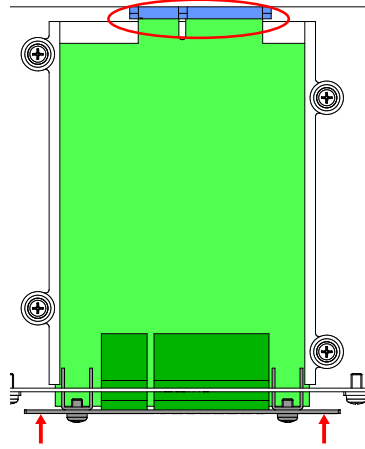

Step 5:

Fasten the module into the slot using the included screws. Be aware that damage or malfunctions may occur if the module is not correctly fastened.

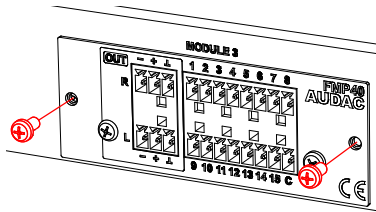

Step 6:

Once the module correctly installed, the system can be powered-on and the module functionality will be automatically discovered.

Chapter 5

Technical specifications

Connection		SourceCon™ interface card slot
Input		F-type antenna connection (75 Ω)
Output		Balanced stereo line output (2 x 3-pin Euro Terminal Block ~ 3.81 mm)
Tuning range	FM	87.5 ~ 108 MHz
	DAB	Band-3: 171 ~ 240 MHz L-band: 1452 ~ 1492 MHz
Sensitivity	FM	-108 dBm
	DAB	-99 dBm
Signal / Noise	FM	52 dB
	DAB	81 dB
THD+N	FM	0.22%
	DAB	0.026%
Frequency response	FM	30 Hz – 12.5 kHz
	DAB	42 Hz – 20 kHz
Crosstalk	FM	26 dB
	DAB	53 dB
Output level		+8 dB ~ -32 dB (Software configurable)
Power consumption		1.5 Watt
Dimensions (W x H x D)		87 x 34.5 x 114 mm
Weight		0.074 Kg
Packaging		Carton box
Shipping weight & Volume		1.08 Kg – 0.028 Cbm
Compatible devices		XMP44 Modular audio system
Optional Accessories	ASK10S	4-Way antenna splitter kit
	RGA10	Omnidirectional outdoor antenna

Notes
